



## Digital Fiber Sensor FS-N10 Series Instruction Manual



Read this manual before using the product in order to achieve maximum performance. Keep this manual in a safe place after reading it so that it can be used at any time.

|                |   |
|----------------|---|
| <b>Danger</b>  | Failure to follow these instructions may lead to death or serious injury.                   |
| <b>Warning</b> | Failure to follow these instructions may lead to injury.                                    |
| <b>Caution</b> | Failure to follow these instructions may lead to product damage (product malfunction, etc.) |

**Note** Provides additional information on proper operation.



This provides useful tips for the feature being described.

See "FS-N10 Series User's Manual" for details on the features of the FS-N10 Series and detailed instructions for configuration.

### Hints on Correct Use

|                |   |
|----------------|---|
| <b>Warning</b> | <ul style="list-style-type: none"> <li>This product is just intended to detect the object(s). Do not use this product for the purpose to protect a human body or a part of human body.</li> <li>This product is not intended for use as explosion-proof product. Do not use this product in a hazardous location and/or potentially explosive atmosphere.</li> <li>This product uses DC power. Do not apply AC power. The product may explode or burn if an AC voltage is applied.</li> </ul> |
|----------------|---|

- Do not wire the amplifier line along with power lines or high-tension lines, as the sensor may malfunction or be damaged due to noise.
- When using a commercially available switching regulator, ground the frame ground terminal and ground terminal.
- Do not use the FS Series outdoors, or in a place where extraneous light can enter the light-receiving element directly.
- Due to individual dispersion characteristics and the difference in fiber unit models, the maximum sensing distance or displayed value may not be the same on all units.
- If the sensor is used for a long time with the APC function enabled and the LED is imposed with a heavy load, the current consumption of the sensor for light emission will become constant and 'END APC' will be displayed. The sensor can still be used in this case. However, replace the sensor if even small changes in received light intensity should be detected for precise detection.

### Precautions on Regulations and Standards

#### UL Certificate

This product is an UL/C-UL Listed product.

- UL File No. E301717
- Category NRKH, NRKH7
- Enclosure Type 1 (Based on UL50)

Be sure to consider the following specifications when using this product as an UL/C-UL Listed Product.

- Use the power supply with Class 2 output defined in NFPA70 (NEC: National Electrical Code).
- Power supply/ Control input/ Control output shall be connected to a single Class 2 source only.
- Use with the over current protection device which is rated 30V or more and not more than 1A.

### Included accessories

- Instruction Manual 1pc.

### FS-N10 Series Quick Start

#### Quick Start

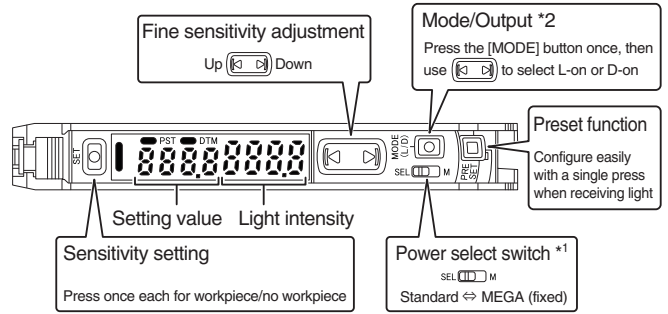

- \*1 This is a channel switch on 2-output types. This is not equipped with the 0-line type.
- \*2 Press and hold the [MODE] button to make advanced setting changes.

### Names of Each Part of the Main Unit and Expansion Unit

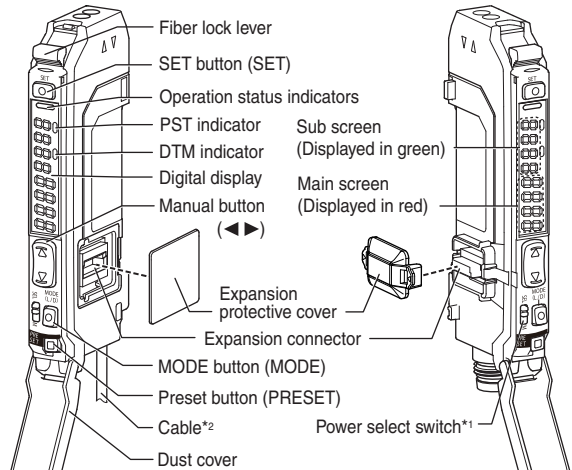

- \*1 Setting to "M" locks the power mode to MEGA mode. The switch is a channel switch for the two output type. This is not equipped with the 0-line type.
- \*2 On the FS-N1□C□, this is an M8 connector rather than a cable. On the FS-N1□EN, this is an e-CON connector.

### Mounting Unit

#### Mounting on a DIN Rail

- Align the claw at the bottom of the main body with the DIN rail, as shown in figure 1. While pushing the main body in the direction of the arrow 1, push down in the direction of arrow 2.
- To dismount the sensor, raise the main body in the direction of the arrow 3 while pushing the main body in the direction of arrow 1.

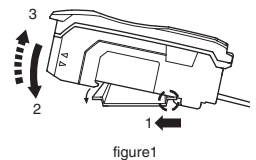

#### Installation on a Wall (Main Unit Only)

- Attach the unit to the optional mounting bracket (OP-73880), and secure with two M3 screws as shown in figure 2.

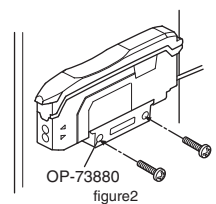

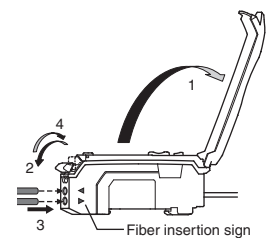

### Connecting Fiber Unit

- Open the dust cover in the direction shown by arrow 1.
- Move the fiber lock lever in the direction shown by arrow 2.
- Insert a fiber unit into the amplifier as indicated by arrow 3 (approximately 14 mm).
- Move the fiber lock lever in the direction shown by arrow 4 to secure the fiber.



**Note** • If a thin fiber unit is used, an adapter provided with the thin fiber unit will be required. Unless the correct adapter is connected, the thin fiber unit will be loose and not detect targets correctly (the adapter is supplied with the fiber unit).

| Cable outer dia | Adapter              | Appearance  |
|-----------------|----------------------|---|
| φ 1.3           | Adapter A (OP-26500) |  |
| φ 1.0           | Adapter B (OP-26501) |  |

• To connect the coaxial reflective type fiber unit to the amplifier, connect the single-core fiber to the transmitter side, and connect the multiple-core fiber to the receiver side.

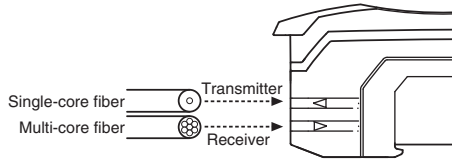

## Connecting Multiple Amplifiers

Up to 16 expansion units can be connected to one main unit. However, two output types will be treated as two main units.

**Warning** Mount on DIN rail and install on metal surface when connecting to multiple amplifiers or mounting main units together.

**Note** • When connecting with units other than N-bus (a general term for the KEYENCE wire-saving connection system) compatible sensor amplifiers, including the FS-N10 Series, and the network unit NU Series, consult your nearest KEYENCE dealer.  
• Turn the power off before connecting multiple expansion units.  
• Do not touch the expansion connector with your bare hands.

**1** Remove the protection covers from the main unit and expansion unit(s).

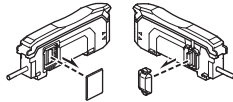

**2** Install the amplifiers on the DIN rail one at a time.

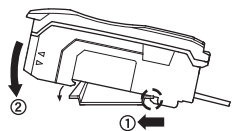

**3** Slide the main unit and expansion unit(s) together. Engage the two claws of the expansion unit with the recesses on the main unit side until you hear/feel a click.

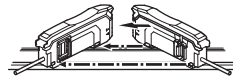

**4** Attach the end units (option: OP-26751) to the DIN rail in the same way as step (2).

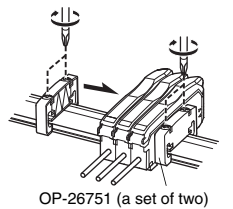

**5** Secure the amplifiers between the end units. Tighten the screws at the top (two screws x two units) with a Phillips screwdriver to fix the end units.

## Calibration Method

### Detecting Even Small Differences

#### Two-point Calibration

Two-point calibration is the basic method of calibration. Press the [SET] button once without the workpiece, and then press it once again with the workpiece.

**1** Press the [SET] button with no workpiece.

[SET] will be displayed on the sub-menu (green display).

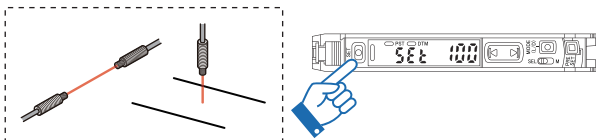

**2** Press the [SET] button with workpiece.

The values will be set and the submenu (green display) will flash. The values will be set to the mid-point between the light intensity when there is no workpiece, and the light intensity when there is a workpiece.

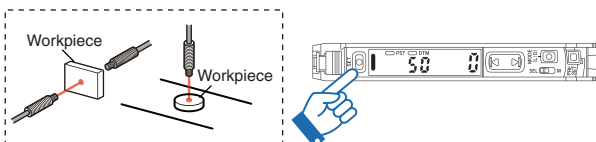

If "----" flashes for two seconds on the main screen, the light intensity is too small between conditions when the workpiece is absent and when it is present. These values will be set, but there is the possibility that detection may become unstable.

## Other Calibration Methods

### Increased Resistance to Dust and Dirt

#### Maximum Sensitivity Calibration

In the state shown below, press and hold the [SET] button for three seconds or more. Stop pushing when "5Et" flashes.

The sensitivity is set slightly higher than the received light intensity.

Thrubeam model : with workpiece

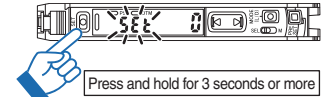
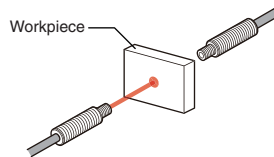

Reflective model : without workpiece

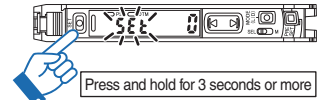

### Calibrate with a Moving Workpiece

#### Fully Automatic Calibration

Press and hold the [SET] button with no workpiece in place. While "SEt" is flashing, pass a workpiece through. (Continue pressing the [SET] button while the workpiece passes through.)

Common to Thrubeam and Reflective Models

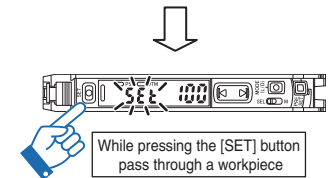
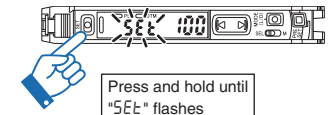
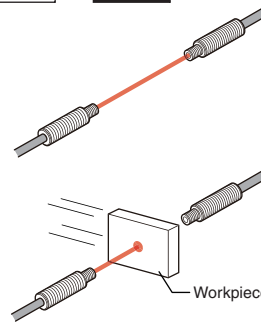

Settings complete

### Position Workpiece

#### Positioning Calibration

Press the [SET] button with no workpiece.

Place the workpiece in the location you wish to position it. Press and hold the [SET] button for at least 3 seconds. Release the button when "5Et" flashes.

Common to Thrubeam and Reflective Models

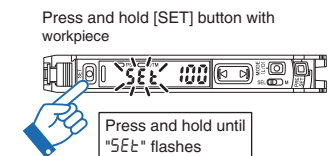
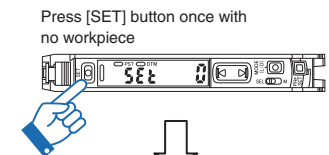
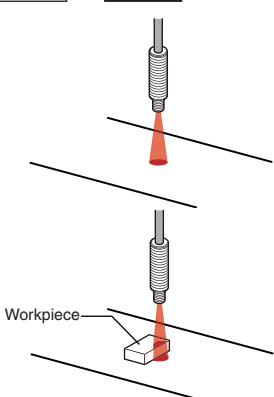

Settings complete

## Simple, User Friendly Functions

### Setting the Current Value to 100.0

With the FS-N10 Series, you can set the current value to 100.0 using simple operations. Standardizing the current value makes it possible for the sensor amplifiers to instantly differentiate reductions in light intensity and is useful in predicting the need for maintenance.

#### Note

- The various Preset functions listed below cannot be used when the Zero-Shift function is enabled. Disable the Zero-Shift function before executing the following functions.
- The Preset functions are not suited for transparent workpieces and other cases of detection with low light intensity differences.



You can disable various Preset functions by pressing and holding the [PRESET] button.

## ● Preset Function

This function adjusts the current value to "1000".  
With light received, press the [PRESET] button. The current value is set to "1000".

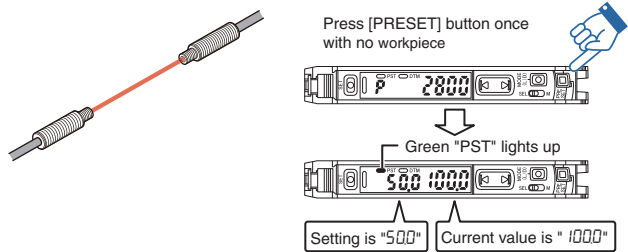

Pressing the [PRESET] button changes the setting and current value as shown below.

- **Presetting with preset disabled:**  
The setting is changed to "500". The setting can be changed via the normal calibration method.
- **Presetting with preset enabled:**  
Only the current value is changed to "1000", and the setting is not changed.



### Handy Uses for the Preset Function

This function is most useful when performing simple detection using a thru-beam model fiber unit (e.g. completely blocked detection, such as when all light axes of the fiber unit are interrupted by opaque workpieces).

## ● Work-Preset Function

This function adjusts the current value to "0".  
After executing the Preset function in a condition in which you would like "1000" to be displayed, executing this function in a condition in which you would like "0" to be displayed, will adjust any two points to "1000" and "0".

**Important** The Work-Preset function can be used while the Preset function is in use (when Preset is enabled).

Pressing the [PRESET] button and the [D] button at the same time will set the current value at that time to "0". Values that have been set to "1000" with the Preset function cannot be changed.

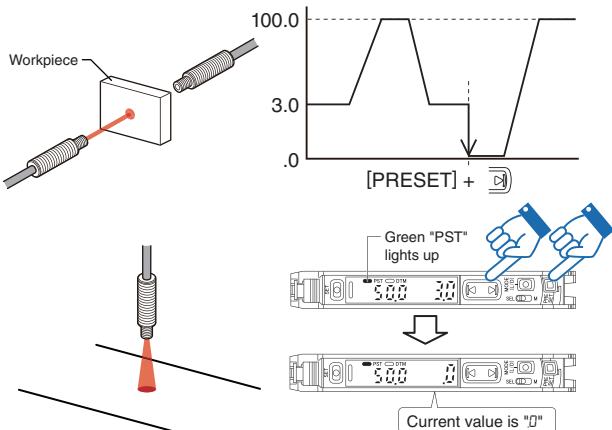

When using this function with reflective models, "1000" will be displayed when there is a workpiece, and "0" will be displayed when there is no workpiece, making it easy to know when the workpiece is present or absent. Additionally, even when with a reflective model, the background has higher light intensity than the workpiece, if you set a condition with low light intensity to "1000" using the Preset function and then using the Work-Preset function, register a condition with high light intensity as "0", the background will display as "0" and when the workpiece is present, it will be displayed as "1000".

## ● Maximum Sensitivity Preset Function

This function sets conditions that will serve as reference, to "0" and adjusts conditions with slightly high light intensity as "1000". This is useful when you would like to perform detection using the background as a reference with reflective models.

In the following conditions, press and hold the [PRESET] button for 3 seconds or more then release your finger when "Auto" is flashed.

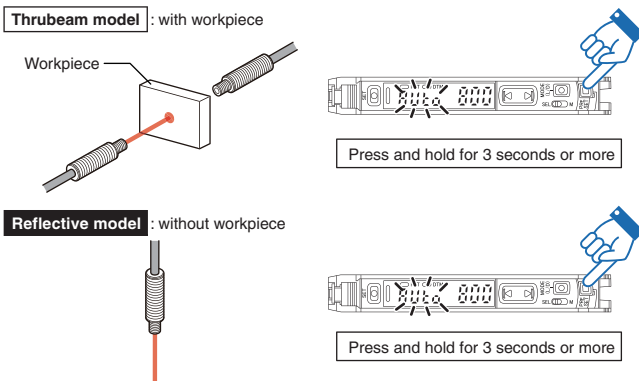

- The maximum value for the light intensity while the [PRESET] button is being pressed is set to "0", and light-intensity that is slightly higher than the maximum value at that time will be adjusted to "1000".
- The setting value is "500"
- The green [PST] indicator will light up.

**Note** Cannot be executed when the Preset function is already being used (when the [PST] indicator is flashing). Press and hold the [PRESET] button to disable the Preset function before executing this function.

## ● Full Auto Preset Function

This function automatically differentiates between two conditions (presence/absence of workpiece) and adjusts the current values to "1000" and "0". This is effective for cases when the workpiece is moving at high-speed.

Press and hold the [PRESET] button with no workpiece in place. While "Auto" is flashing, pass a workpiece through. (Continue pressing the [PRESET] button while the workpiece passes through.)

Common to **Thru-beam** and **Reflective** Models

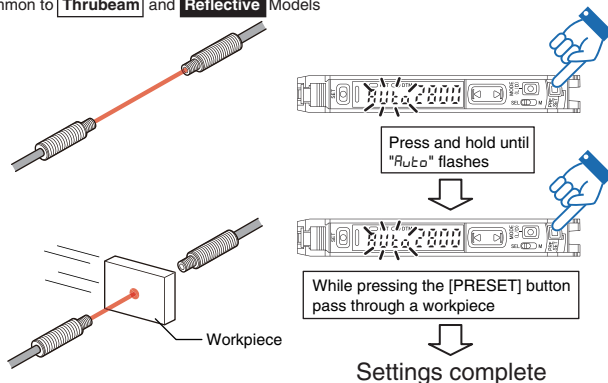

- Near-maximum values while the [PRESET] button is being pressed and held are adjusted to "1000" and near-minimum values are adjusted to "0".
- The setting value is changed to "500"
- The green [PST] indicator will light up.

**Note** Cannot be executed when the Preset function is already being used (when the [PST] indicator is flashing). Press and hold the [PRESET] button to disable the Preset function before executing this function.

## ■ Set Current Value to "0"

### ● The Zero Shift Function

This function is primarily used with reflective models.  
Press the [PRESET] button and [D] button at the same time.

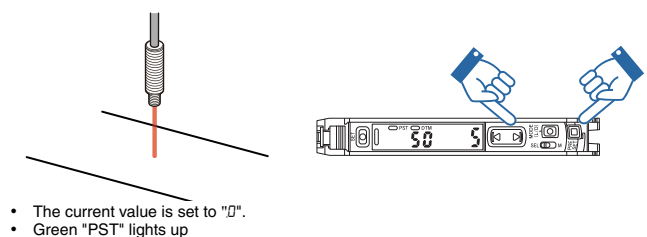

- The current value is set to "0".
- Green "PST" lights up

**Note** The zero shift and preset function cannot be used together. To use the preset function, you must first disable the zero shift function.

### ● Disable the Zero Shift Function

Press and hold the [PRESET] button to disable the zero shift function.



### Handy Uses for the Zero Shift Function

This function is primarily used to set the current value to "0" on a reflective model fiber unit.

When a reflective model is first installed, the light intensity is sometimes not set to "0".

If this happens, using the zero shift function to set the value to "0" when there is no workpiece allows for easier understanding of the difference in light intensity.

## ■ Adjusting the current intensity value when it is too large (when saturated).

### ● Use the Saturation Recovery Function

Press the [SET] button while pressing the [MODE] button.

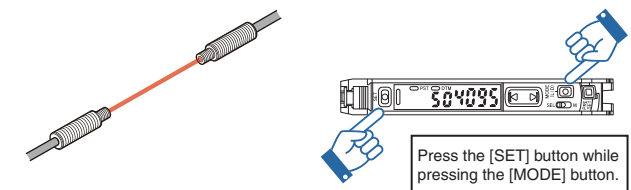

After adjusting the light transmission level and light intensity sensitivity, the current values will be adjusted to within the ranges listed in the table that follows.

| Power mode       | Light intensity setting range |
|------------------|-------------------------------|
| HSP, FINE, TURBO | 2047 ± 350                    |
| SUPER            | 4095 ± 500                    |
| ULTRA, MEGA      | 5000 ± 600                    |

\*HIGH SPEED

### ● Disable Saturation Recovery

When the saturation recovery function is enabled, press the [SET] button while pressing the [MODE] button to cancel it.



### Handy Uses for the Saturation Recovery Function

This function is useful when the intensity value is saturated after installation. This function corrects the saturation via a simple operation, by automatically calibrating the light transmission level and light intensity gain.

## Output Switch

Either light-ON (L-on) mode or dark-ON (D-on) mode can be selected.

- 1 While the current value is displayed, press the [MODE] button once.



- 2 Use to switch the output (L-on/d-on), then press the [MODE] button again. The output change completes, and the display returns to the current value.

## Connecting to External Devices

### Cable Types

#### FS-N11N/N12N/N13N/N14N

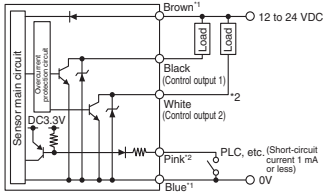

- \*1 FS-N11N/N13N only
- \*2 FS-N13N/N14N only

#### FS-N11P/N12P/N13P/N14P

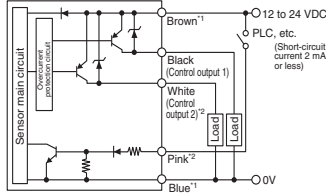

- \*1 FS-N11P/N13P only
- \*2 FS-N13P/N14P only

#### FS-N11MN

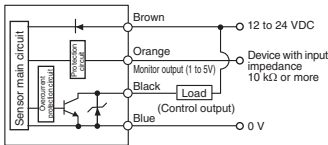

### M8/e-CON Connector Types

#### FS-N11CN/N12CN/N11EN/N12EN

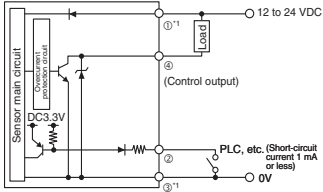

- \*1 FS-N11CN/N11EN only



#### FS-N11CP/N12CP/N13CP/N14CP

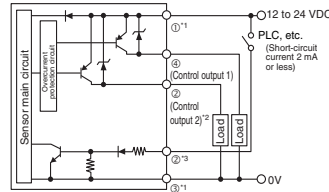

- \*1 FS-N11CP/N13CP only
- \*2 FS-N13CP/N14CP only
- \*3 FS-N11CP/N12CP only



### M8 connector Cable (Sold Separately)

For FS-N11CN/N11CP/N12CN/N12CP/N13CP/N14CP

OP-73864  
(Cable length: 2 m)  
OP-73865  
(Cable length: 10 m)

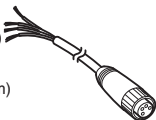

Pin - Pin and wire color table

| Connected pin No. | Wire color |
|-------------------|------------|
| 1                 | Brown      |
| 2                 | White      |
| 3                 | Blue       |
| 4                 | Black      |

## Error Displays and Corrective Actions

| Error display | Cause                                   | Solution   |
|---------------|---|--|
| ErC           | Overcurrent in the control output.      | Check the load and return the current within the rated value.      |
| ErE           | Failed to write/load the internal data. | Perform initialization (p.4).                                      |
| End APC       | Large load on the light source.         | Replace the sensor if highly precise detection is required.        |
| Loc           | The keylock function is ON.             | For disabling (setting) method, see "FS-N10 Series User's Manual". |

Consult your nearest KEYENCE office regarding error displays other than the ones listed above.

## Initializing the Settings

### Initialization Method

- 1 Press and hold the [SET] and [PRESET] buttons simultaneously for three seconds.

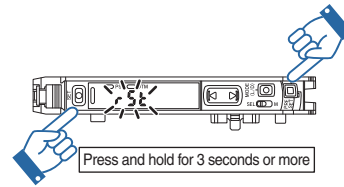

- 2 Use the to select "5t", then press the [MODE] button.
- 3 Use the to select "init", then press the [MODE] button. After initialization is complete, the display returns to the current value.

### Initial Settings

| Setting        | Initial Value |
|----------------|---------------|
| Power mode     | FINE          |
| Detection mode | Std (Normal)  |
| Setting value  | 50            |
| Output switch  | L-on          |

## Using a Fiber Cutter and Cautions for Use

### Using a Fiber Cutter

- 1 Insert the fiber into the cutter hole.
- 2 Bring down the blade in a single, swift motion to cut the fiber.

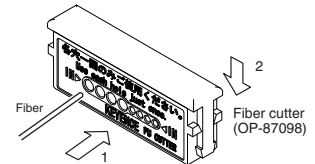

Always insert fiber from the side with writing

### Cautions for Using a Fiber Cutter

- The fiber cutter comes with the fiber unit.

Failure to follow the cautions below could reduce the detection range.

- When cutting a fiber unit to be attached to the FS-N10 Series, be sure to use a gray fiber cutter (OP-87098)
- Stopping the blade midway could cause a bad cut plane, reducing the detection range.
- Do not use the same hole twice.

## Function Configuration

### Basic Setting

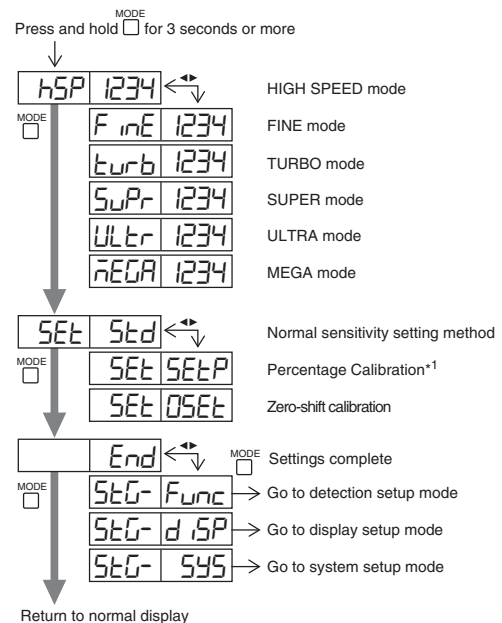

- \*1 You can press the button to set between the range of -99P to 99P.



# Specifications

| Type                                    | Standard 1 output   |   |   |                                    |                               |                                    |            | High functionality 2 output        |                            |                                    |            | Monitor output                        | O-line   |
|---|---|---|---|------------------------------------|-------------------------------|------------------------------------|------------|------------------------------------|----------------------------|------------------------------------|------------|---------------------------------------|--|
| Cable/M8 connector                      | Cable   |   | M8 connector <sup>*1</sup>  |                                    | e-CON connector <sup>*1</sup> |                                    | Cable      |                                    | M8 connector <sup>*1</sup> |                                    | Cable      | -                                     |  |
| Main unit/expansion unit                | Main unit   | Expansion unit (with output cable)  | Main unit   | Expansion unit (with output cable) | Main unit                     | Expansion unit (with output cable) | Main unit  | Expansion unit (with output cable) | Main unit                  | Expansion unit (with output cable) | Main unit  | Expansion unit (without output cable) |  |
| Model                                   | NPN   | FS-N11N   | FS-N12N   | FS-N11CN                           | FS-N12CN                      | FS-N11EN                           | FS-N12EN   | FS-N13N                            | FS-N14N                    | -                                  | -          | FS-N11MN                              | FS-N10   |
|   | PNP   | FS-N11P   | FS-N12P   | FS-N11CP                           | FS-N12CP                      | -                                  | -          | FS-N13P                            | FS-N14P                    | FS-N13CP                           | FS-N14CP   | -                                     | -  |
| Control output                          | 1 output  | 1 output  | 1 output  | 1 output                           | 1 output                      | 1 output                           | 1 output   | 2 output                           | 2 output                   | 2 output                           | 2 output   | 1 output                              | N/A <sup>*2</sup>  |
| Monitor output (1 to 5 V)               | -   | -   | -   | -                                  | -                             | -                                  | -          | -                                  | -                          | -                                  | -          | 1 output                              | -  |
| External input                          | -   | -   | 1 input   | 1 input                            | 1 input                       | 1 input                            | 1 input    | 1 input                            | 1 input                    | -                                  | -          | -                                     | -  |
| Light source LED                        | Red 4-element LED (wavelength 630 nm)   |   |   |                                    |                               |                                    |            |                                    |                            |                                    |            |                                       |  |
| Response time                           | 50 μs (HIGH SPEED)/250 μs (FINE)/500 μs (TURBO)/1 ms (SUPER)/4 ms (ULTRA)/16 ms (MEGA)  |   |   |                                    |                               |                                    |            |                                    |                            |                                    |            |                                       |  |
| Output toggle                           | Light-ON/dark-ON toggle   |   |   |                                    |                               |                                    |            |                                    |                            |                                    |            |                                       |  |
| Timer function                          | Timer OFF, OFF delay, ON delay, One-shot  |   |   |                                    |                               |                                    |            |                                    |                            |                                    |            |                                       |  |
| Control output                          | NPN output  | NPN open collector 24 V; 1 output max: 100 mA or less; 2 output total: 100 mA or less (used stand-alone)/20 mA or less (multiple connections); residual voltage 1 V or less   |   |                                    |                               |                                    |            |                                    |                            |                                    |            |                                       |  |
|   | PNP output  | PNP open collector 24 V; 1 output max: 100 mA or less; 2 output total: 100 mA or less (used stand-alone)/20 mA or less (multiple connections); residual voltage 1 V or less   |   |                                    |                               |                                    |            |                                    |                            |                                    |            |                                       |  |
| Monitor output <sup>*3</sup>            | 1 to 5 V voltage output; load resistance 10 kΩ or more; repeat precision ± 0.5% of F.S.; 1 ms response time (HIGH SPEED, FINE, TURBO) <sup>*4</sup> |   |   |                                    |                               |                                    |            |                                    |                            |                                    |            |                                       |  |
| External input                          | input time 2 ms (ON)/20 ms (OFF) or more <sup>*5</sup>  |   |   |                                    |                               |                                    |            |                                    |                            |                                    |            |                                       |  |
| Expansion Units                         | Up to 16 units can be connected (total of 17 units including the main unit). Note that the two-output type is counted as two units.                 |   |   |                                    |                               |                                    |            |                                    |                            |                                    |            |                                       |  |
| Protection circuit                      | Protection against reverse power connection, output overcurrent, and output surge   |   |   |                                    |                               |                                    |            |                                    |                            |                                    |            |                                       |  |
| Number of interference prevention units | 0 for HIGH SPEED; 4 for FINE; 8 for TURBO/SUPER/ULTRA/MEGA (When set to double, the number of interference-prevention units will be doubled.)       |   |   |                                    |                               |                                    |            |                                    |                            |                                    |            |                                       |  |
| Rating                                  | Power voltage   | 12 to 24 V DC ± 10% ripple (P-P) 10% or less  |   |                                    |                               |                                    |            |                                    |                            |                                    |            |                                       |  |
|   | NPN   | Normal: 900 mW or less (36 mA max. at 24 V, 48 mA max. at 12 V) <sup>*6</sup><br>Eco on mode: 800 mW or less (32 mA max. at 24 V, 39 mA max. at 12 V) <sup>*6</sup><br>Eco Full mode: 470 mW or less (19 mA max. at 24 V, 23 mA max. at 12 V) |   |                                    |                               |                                    |            |                                    |                            |                                    |            |                                       |  |
|   | PNP   | Normal  | : 950 mW or less (39 mA max. at 24 V, 52 mA max. at 12 V) <sup>*6</sup> |                                    |                               |                                    |            |                                    |                            |                                    |            | Normal                                | : 1050 mW or less (42 mA max. at 24 V, 56 mA max. at 12 V) <sup>*6</sup> |
|   |   | Eco on mode   | : 850 mW or less (35 mA max. at 24 V, 44 mA max. at 12 V) <sup>*6</sup> |                                    |                               |                                    |            |                                    |                            |                                    |            | Eco on mode                           | : 950 mW or less (38 mA max. at 24 V, 47 mA max. at 12 V) <sup>*6</sup>  |
|   |   | Eco Full mode   | : 520 mW or less (21 mA max. at 24 V, 26 mA max. at 12 V)               |                                    |                               |                                    |            |                                    |                            |                                    |            | Eco Full mode                         | : 600 mW or less (24 mA max. at 24 V, 29 mA max. at 12 V)                |
| Environmental resistance                | Operating ambient luminance   | Incandescent lamp: 20,000 lx or less; Sunlight: 30,000 lx or less   |   |                                    |                               |                                    |            |                                    |                            |                                    |            |                                       |  |
|   | Operating ambient temperature   | -20 to +55 °C (no freezing) <sup>*7</sup>   |   |                                    |                               |                                    |            |                                    |                            |                                    |            |                                       |  |
|   | Operating ambient humidity  | 35 to 85% RH (no condensation)  |   |                                    |                               |                                    |            |                                    |                            |                                    |            |                                       |  |
|   | Vibration resistance  | 10 to 55 Hz Compound amplitude 1.5 mm, 2 hours for each of X,Y,Z axis   |   |                                    |                               |                                    |            |                                    |                            |                                    |            |                                       |  |
|   | Shock resistance  | 500 m/s <sup>2</sup> 3 times for each of X,Y,Z axis   |   |                                    |                               |                                    |            |                                    |                            |                                    |            |                                       |  |
| Case material                           | Both main unit and expansion unit housing material: Polycarbonate   |   |   |                                    |                               |                                    |            |                                    |                            |                                    |            |                                       |  |
| Case dimensions                         | H30.3mm x W9.8mm x L71.8mm  |   |   |                                    |                               |                                    |            |                                    |                            |                                    |            |                                       |  |
| Weight                                  | Approx 75g  | Approx 45g  | Approx 22g  | Approx 22g                         | Approx 22g                    | Approx 22g                         | Approx 22g | Approx 80g                         | Approx 70g                 | Approx 22g                         | Approx 22g | Approx 75g                            | Approx 20g   |

\*1 Use a cable length of 30 m or less for M8 connector and e-CON connector types.

\*2 Counted as 1 output when connecting with the network unit NU Series.

\*3 FS-N11MN only

\*4 SUPER : 1.2 ms, ULTRA : 1.8ms, MEGA : 4.2 ms

\*5 Input time is 25 ms (ON)/25 ms (OFF) only when external calibration input is selected.

\*6 Increases 100 mW (4.0 mA) for High Speed mode

\*7 One or two more units connected: -20 to +55 °C; 3 to 10 more units connected: -20 to +50 °C; 11 to 16 more units connected: -20 to +45 °C. When using 2-outputs, one unit is counted as two units. All temperature regulations are for when the unit is mounted on a DIN rail and installed on metal sheeting.

## WARRANTIES AND DISCLAIMERS

- KEYENCE warrants the Products to be free of defects in materials and workmanship for a period of one (1) year from the date of shipment. If any models or samples were shown to Buyer, such models or samples were used merely to illustrate the general type and quality of the Products and not to represent that the Products would necessarily conform to said models or samples. Any Products found to be defective must be shipped to KEYENCE with all shipping costs paid by Buyer or offered to KEYENCE for inspection and examination. Upon examination by KEYENCE, KEYENCE, at its sole option, will refund the purchase price of, or repair or replace at no charge any Products found to be defective. This warranty does not apply to any defects resulting from any action of Buyer, including but not limited to improper installation, improper interfacing, improper repair, unauthorized modification, misapplication and mishandling, such as exposure to excessive current, heat, coldness, moisture, vibration or outdoors air. Components which wear are not warranted.
- KEYENCE is pleased to offer suggestions on the use of its various Products. They are only suggestions, and it is Buyer's responsibility to ascertain the fitness of the Products for Buyer's intended use. KEYENCE will not be responsible for any damages that may result from the use of the Products.
- The Products and any samples ("Products/Samples") supplied to Buyer are not to be used internally in humans, for human transportation, as safety devices or fail-safe systems, unless their written specifications state otherwise. Should any Products/Samples be used in such a manner or misused in any way, KEYENCE assumes no responsibility, and additionally Buyer will indemnify KEYENCE and hold KEYENCE harmless from any liability or damage whatsoever arising out of any misuse of the Products/Samples.
- OTHER THAN AS STATED HEREIN, THE PRODUCTS/SAMPLES ARE PROVIDED WITH NO OTHER WARRANTIES WHATSOEVER. ALL EXPRESS, IMPLIED, AND STATUTORY WARRANTIES, INCLUDING, WITHOUT LIMITATION, THE WARRANTIES OF MERCHANTABILITY, FITNESS FOR A PARTICULAR PURPOSE, AND NON-INFRINGEMENT OF PROPRIETARY RIGHTS, ARE EXPRESSLY DISCLAIMED. IN NO EVENT SHALL KEYENCE AND ITS AFFILIATED ENTITIES BE LIABLE TO ANY PERSON OR ENTITY FOR ANY DIRECT, INDIRECT, INCIDENTAL, PUNITIVE, SPECIAL OR CONSEQUENTIAL DAMAGES (INCLUDING, WITHOUT LIMITATION, ANY DAMAGES RESULTING FROM LOSS OF USE, BUSINESS INTERRUPTION, LOSS OF INFORMATION, LOSS OR INACCURACY OF DATA, LOSS OF PROFITS, LOSS OF SAVINGS, THE COST OF PROCUREMENT OF SUBSTITUTED GOODS, SERVICES OR TECHNOLOGIES, OR FOR ANY MATTER ARISING OUT OF OR IN CONNECTION WITH THE USE OR INABILITY TO USE THE PRODUCTS, EVEN IF KEYENCE OR ONE OF ITS AFFILIATED ENTITIES WAS ADVISED OF A POSSIBLE THIRD PARTY'S CLAIM FOR DAMAGES OR ANY OTHER CLAIM AGAINST BUYER. In some jurisdictions, some of the foregoing warranty disclaimers or damage limitations may not apply.**

### BUYER'S TRANSFER OBLIGATIONS:

If the Products/Samples purchased by Buyer are to be resold or delivered to a third party, Buyer must provide such third party with a copy of this document, all specifications, manuals, catalogs, leaflets and written information provided to Buyer pertaining to the Products/Samples.

## KEYENCE CORPORATION

1-3-14, Higashi-Nakajima, Higashi-Yodogawa-ku,  
Osaka, 533-8555, Japan  
PHONE: +81-6-6379-2211

[www.keyence.com](http://www.keyence.com)

|  |   |   |
|--|---|---|
| <b>AUSTRIA</b><br>Phone: +43-2236-378266-0       | <b>HUNGARY</b><br>Phone: +36 14 748 313       | <b>SINGAPORE</b><br>Phone: +65-6392-1011          |
| <b>BELGIUM</b><br>Phone: +32 1 528 12 22         | <b>ITALY</b><br>Phone: +39-2-6688220          | <b>SLOVAKIA</b><br>Phone: +421 2 5939 6461        |
| <b>CANADA</b><br>Phone: +1-905-696-9970          | <b>JAPAN</b><br>Phone: +81-6-6379-2211        | <b>SWITZERLAND</b><br>Phone: +41 43 455 77 30     |
| <b>CHINA</b><br>Phone: +86-21-68757500           | <b>KOREA</b><br>Phone: +82-31-642-1270        | <b>TAIWAN</b><br>Phone: +886-2-2718-8700          |
| <b>CZECH REPUBLIC</b><br>Phone: +420 222 191 483 | <b>MALAYSIA</b><br>Phone: +60-3-2092-2211     | <b>THAILAND</b><br>Phone: +66-2-369-2777          |
| <b>FRANCE</b><br>Phone: +33 1 56 37 78 00        | <b>MEXICO</b><br>Phone: +52-81-8220-7900      | <b>UK &amp; IRELAND</b><br>Phone: +44-1908-696900 |
| <b>GERMANY</b><br>Phone: +49-6102-36 89-0        | <b>NETHERLANDS</b><br>Phone: +31 40 20 66 100 | <b>USA</b><br>Phone: +1-201-930-0100              |
| <b>HONG KONG</b><br>Phone: +852-3104-1010        | <b>POLAND</b><br>Phone: +48 71 36861 60       |   |

Specifications are subject to change without notice.

A6WW1-MAN-1090

Copyright (c) 2010 KEYENCE CORPORATION. All rights reserved.  
11513E 1120-1 [96M11513] Printed in Japan

